

You must install a 30 mA residual-current device (RCD).

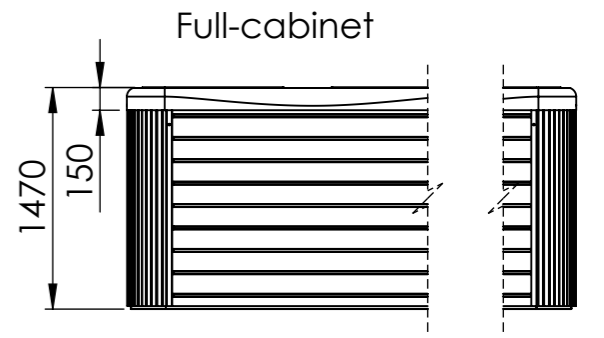
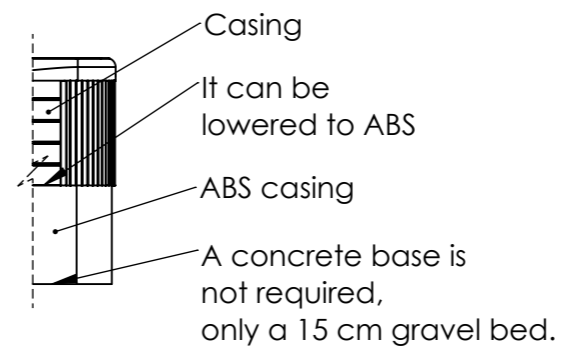
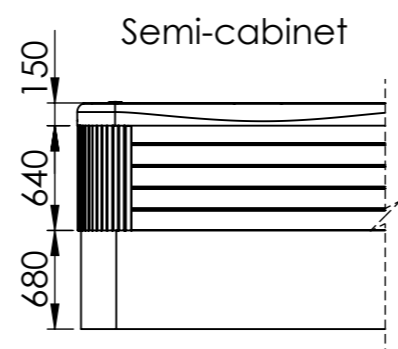

Product family: Swim Life

No.	Part No.	Description	Pcs.
1	ASE0126	Rubber bush M8x15/M8x30	16
2	ASE0007-K	Nut M8	28
3	ASE0006-K	Woodscrew - 4 x 70	28
4	ACM1092	UL ozone	1
5	ACM0954	Motor 50Hz anti-current arrester 2200W (WP300a-II)	2
6	ASE0005-K	Washer M6 wood connection	8
7	ACM0394	Spa Pump 3/0.6 HP - Two Speed	1
8	ACM0846	Circulation pump WTC50M 250 W 0.33 Hp	1
9	AJ00281	Sealing for self adjusting suction head nut Life	8
10	AJ00280	Self adjusting nut for suction head Life	8
11	AE00658	Silicone sealing for suction 2"	6
12	AJ00220	Jet 2" - transparent 1 Hole transparent V3 neutral	6
13	AJ00223	Jet 3" - transparent 1 Hole rotational transparent V3 neutral	18
14	AF00061	Pillow 300x126x54 white ribbed	2
15	AKU2717	Air regulator grip light gray Life Wellis	2
16	AKU2719	On-off tap grip light gray Life Wellis	1
17	AKU1894	Water Diverter - Grip Wellis V2	1
18	ACM0959	Control Panel - IN.K500 GECKO	1
19	AKU1893	On-Off tap house 33 transparent V2	1
20	AKU1892	Air Regulator - house led lighted V2	2
21	AKU2625	Fountain laminar V3	6
22	AKU2157	Adapter for swimming stick	1
23	ABE00892	Binding pad	3
24	ABE0505	Suction head 2.5" Chrome (high)	8
25	AJ00253	Jet house 2" with sealing V4 1/3	6
26	AJ00287	Nozzle housing nut self-aligning 2" V5 2/3	6
27	AJ00288	Washer for washer housing 2" V5 3/3	6
28	AJ00254	Jet house 3" with sealing V4 1/3	18
29	AJ00290	Washer for washer housing 3" V5 3/3	18
30	AJ00289	Jet housing nut self-aligning 3"	18
31	AJ00284	Circulation jet washer self-aligning 48 Life	1
32	AJ00283	Circulation jet nut self-aligning 48 Life	1
33	AJ00169	Jet - 20 SB - Ozone 90°	1
34	AKU1830	Filter house for floating 50 sqf filters	2
35	ACM0531	Underwater Light - House RD	1
36	AJ00185	JETSWIMSPA - River	3
37	ABE0380	Plug 33 V2	3
38	AKU1891	Water Diverter 60 - LED lighted V2	1
39	AKU2095	Protective grid for floating filter	2
40	ASE0004-K	Nut M6	8
41	ACM0756	Control box In.YE-5	1
42	AJ00282	Circulation jet Medium gray 48 mm Life	1

Sheet name: Danube Riverjet EU_ENG		Projection		
File name: FJ_WU00043_HUN_ENG_Danube_Riverjet_EU_medence				
Dimension SPA 2350x4530x1470 mm		Min.El. nds.: 400 V - 3x16A - 50Hz / Opt.El. needs: 400V - 3x16A - 50Hz		
1 person ~75 kg	Weight of the SPA kg	Control box: GECKO YE-5 (3kW) + K500		
Water disp.: 225 kg	Rim height: 150 mm	Approved by: Frankó Csaba	Pr. No: Fe. No:	Number: WU00043
Minimum water: 5913 liter	Created: 2024. 08. 01.	Drawer: franko.csaba - 2024. 08. 01. 11:37:03	A3	M 1:50

INSTALLATION INSTRUCTIONS

Installation, connection and electrical installation can be done only by professionals!

The given dimensions are for information only, they may differ from reality due to the manufacturing technology of pools.

ATTENTION!

Pools can be installed only when electric shock protection compliance of the installed residual-current device is stated by the installation personnel in written form.

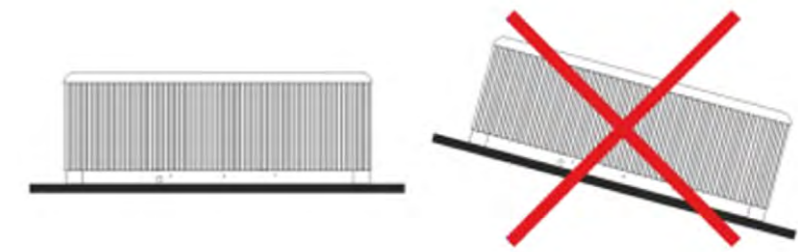

1. General installation instructions

A solid, level base (maximum 0.5% slope) is essential for setting up the pool. Make sure the cover or base is properly supporting the pool.

For this, you need to know the maximum load capacity of the cover. Consult a qualified architectural professional or structural engineer. To determine the weight, contents and parts of the pool, refer to the data table of the pool. This weight should not exceed the calculated static capacity per square meter, otherwise it may cause serious damage to the pool and the substrate. **60 cm of space is required around the pool**

provided for servicing, if this cannot be done, in the event of servicing, advance notice must be given and access to the pool must be ensured! It is advisable to create a water confluence on the outlet side of the pool. Its purpose is to drain rainwater and splashing water from around the pool, and also to allow the water to flow away in case the pool is lowered at the bottom outlet.

a. Indoors/Basement

In case of placing the pool inside a building take into consideration the following requirements: The base must have a proper drain channel to prevent water collecting around the pool.

In case a new place is built for the pool, it is strongly recommended to install a floor drain to prevent damage due to water overflow or mechanical failure, etc.

If no floor drain is installed, our Company takes no responsibility for occurring damages.

Inside the room where the pool is installed, humidity can increase significantly. To prevent precipitating water and the occurrence of fungus, proper ventilation of the room is highly recommended.

It is also suggested to install a dehumidifier device in the room. Acrylic absorbs heat from the sun rapidly, due to which the pool can suffer significant heat damage. In case the pool is installed between glass structures, please prevent the sunrays to reach the pool directly through the glass, otherwise temperatures can rise too high.

b. Outdoors/Closed terrace

If the pool is installed outdoors, it is recommended to build a horizontal, reinforced concrete base with min. 10-15 cm thickness. Do not expose the empty pool direct sunlight without proper protection (thermal cover on top). Please keep in mind that long term exposure to sunlight will damage the pool and its accessories.

c. Recessed installation

In case of recessed installation a **60 cm wide manhole must be built around the pool** for proper access and servicing.

Only the part of the pool that is **under the acrylic rim** can be recessed. In case these conditions are not met, installation of the pool may fail!

It is appropriate to make the drain channel in the base on the drain side of the pool. Its purpose is to take away splash water around the pool, or drain the released water.

It is also necessary to provide water drainage in the manhole.

The manhole should also ventilate properly. It is recommended to install an exhaust fan or other ventilation device.

If raising the pool from its recessed place is necessary, the customer is responsible for all related expenses.

2. Electrical installation

You must install a circuit breaker dedicated only for the pool, no other devices allowed to connect. You must also install a 30mA residual-current device (RCD).

Check your product type: WU00043 Danube Riverjet EU

Check the minimal electric needs of your product: 400V 3x16A 50Hz

Check the optimal electric needs of your product: 400V 3x16A 50HZ

Based on the information above, choose the appropriate cable size for your product.

For electric installation in case of cables not exceeding 10 meters in length, the appropriate cable cross section and length is given in the table on the right.

- For cable lengths exceeding 10 meters please consult a professional!

- In all cases, the electrical installation of the pool has to be done by an electrician.

- In case the optimal energy needs of the pool are met: the Spa pump and heating can work simultaneously.

- In case only the minimal energy needs of the pool are met: the Spa pump and heating can not work simultaneously.

- Installing the cables is recommended through the bottom cover (tray) by drilling a hole and using a cable gland. Recommended direction is shown on the drawing.

Min. cable length for installation is 3 m.

- The exact way of electrical installation is always unique, highly dependant on the location and environment of the pool.

Additional electrical installation (cable, circuit breaker and residual-current device) is the customer's responsibility.

These parts are not included in the pool packaging, need to be purchased separately.

Every pool has a dedicated installation drawing.

Make sure that the pool is connected to a 30 mA residual-current device.

Use copper wiring only.



If a fuse fails, replace it only with same type of fuse with same technical parameters.

The device must be connected to the house's Equipotential Bonding Grid.

We inform you that the functioning of Spa pumps listed in the bill of materials on the first page may differ from reality. For example, if 'ACM0394 Spa Pump 3/0.6 HP - Two Speed' pump is listed as two speed, but in reality it only works with one speed, that might be because for the best massage experience a bigger influx of water is needed, thus the pump will work with its highest speed.

Kábel keresztmetszet/ Cable profile		
1x16A	3x2,5mm ²	230 V
1x20A	3x4mm ²	230 V
1x25A	3x4mm ²	230 V
3x16A	5x4mm ²	400 V

Product family: Swim Life

Sheet name: INFO_ENG	Projection 	
File name: FJ_WU00043_HUN_ENG_Danube_Riverjet_EU_medence		
Dimension SPA: 2350x4530x1470 mm	Min.El. nds: 400 V - 3x16A - 50Hz / Opt.El. needs: 400V - 3x16A - 50Hz	
Weight of the SPA: kg	Control box: GECKO YE-5 (3kW) + K500	
Rim height: 150 mm	Approved by: Frankó Csaba	Pr. No: Fe. No:
Minimum water: 5913 liter	Created: 2024. 08. 01.	Number: WU00043
	Drawer: franko.csaba - 2024. 08. 01. 11:37:03	A3 M 1:15 page 5 / 6

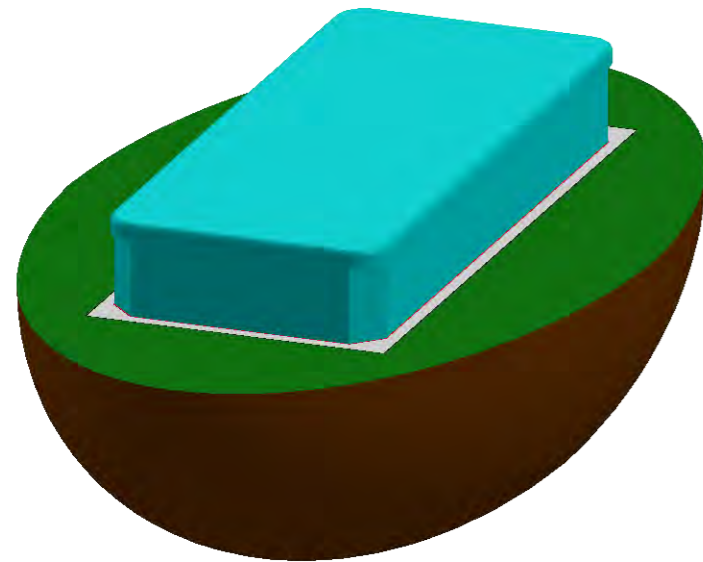
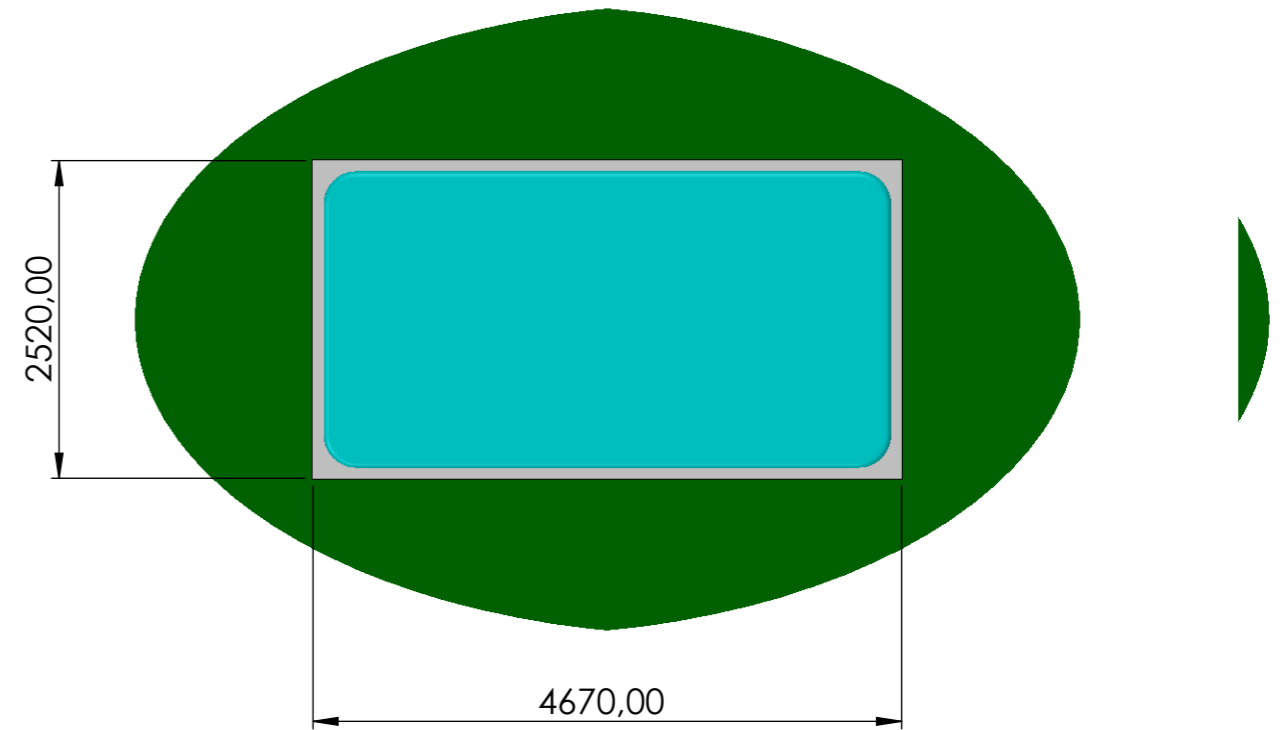
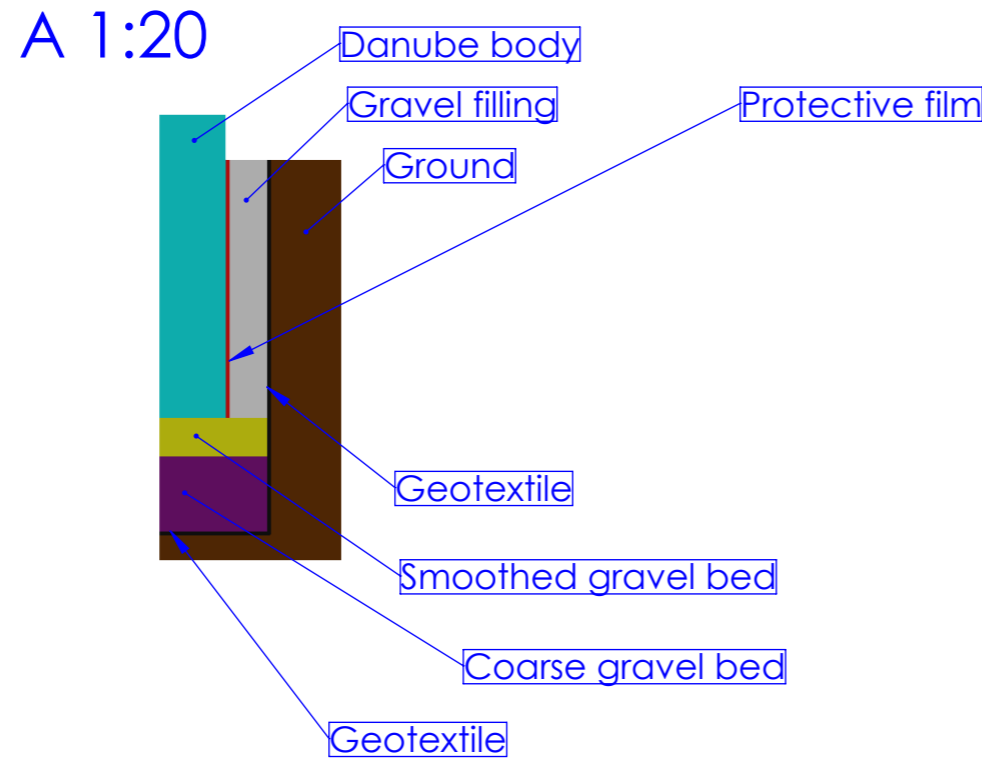
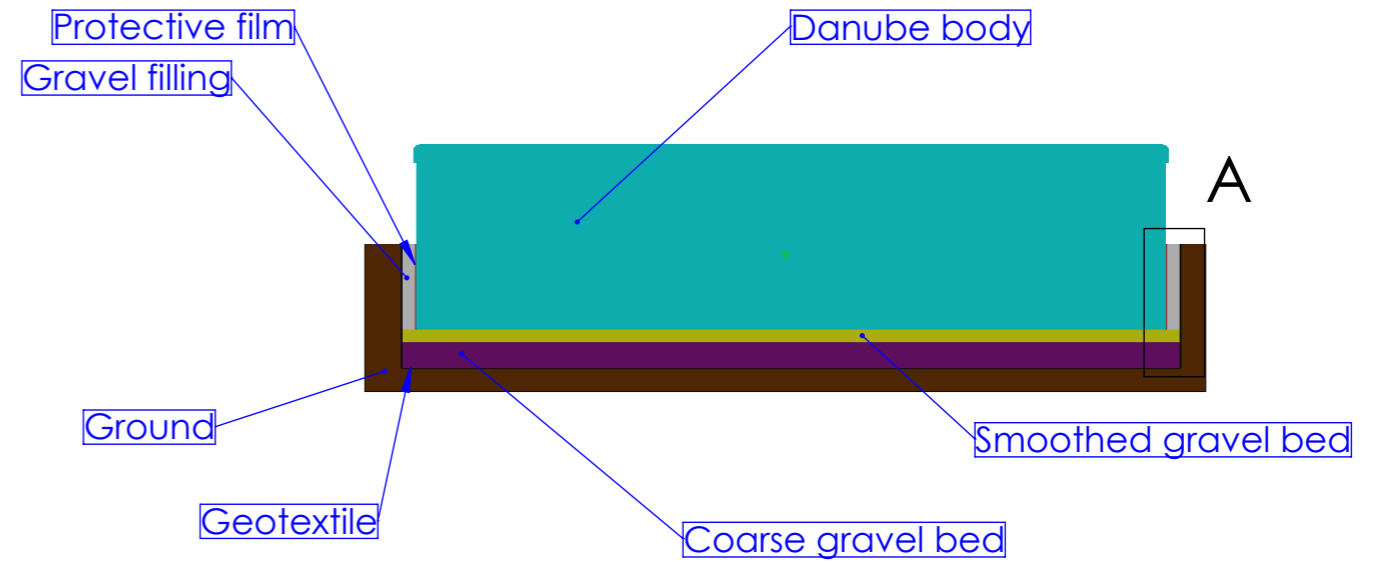
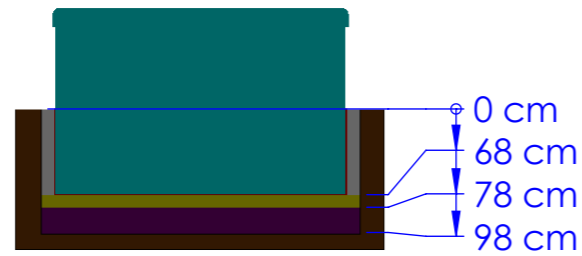

Product family: Swim Life

Sheet name: SEMICABINET_ENG		Projection			
File name: FJ_WU00043_HUN_ENG_Danube_Riverjet_EU_medence					
Dimension SPA 2350x4530x1470 mm		Min.El.nds.: 400 V - 3x16A - 50Hz / Opt.El.needs: 400V - 3x16A - 50Hz			
1 person ~75 kg		Weight of the SPA: kg		Control box: GECKO YE-5 (3kW) + K500	
Water disp.: 225 kg		Rim height: 150 mm		Approved by: Frankó Csaba	
Minimum water: 5913 liter		Created: 2024. 08. 01.		Drawer: franko.csaba - 2024. 08. 01. 11:37:03	
				Pr. No: Fe. No:	
				Number: WU00043	
				A3 M 1:17 page 6 / 6	